

MIPOLAM SPM WALL

gerflorusa.com

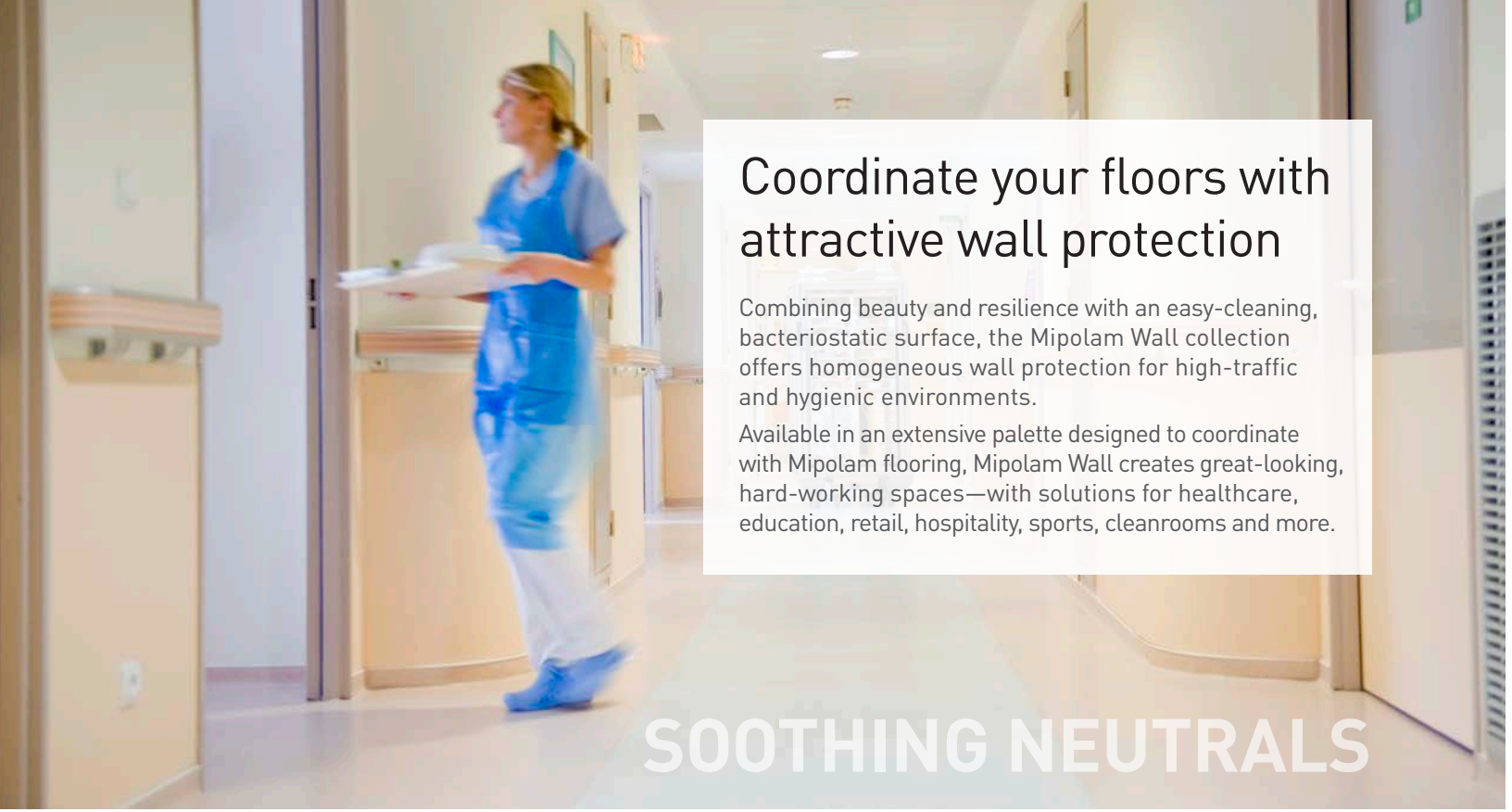

Gerflor[®]
the flooring group



Coordinate your floors with attractive wall protection

Combining beauty and resilience with an easy-cleaning, bacteriostatic surface, the Mipolam Wall collection offers homogeneous wall protection for high-traffic and hygienic environments.

Available in an extensive palette designed to coordinate with Mipolam flooring, Mipolam Wall creates great-looking, hard-working spaces—with solutions for healthcare, education, retail, hospitality, sports, cleanrooms and more.

SOOTHING NEUTRALS

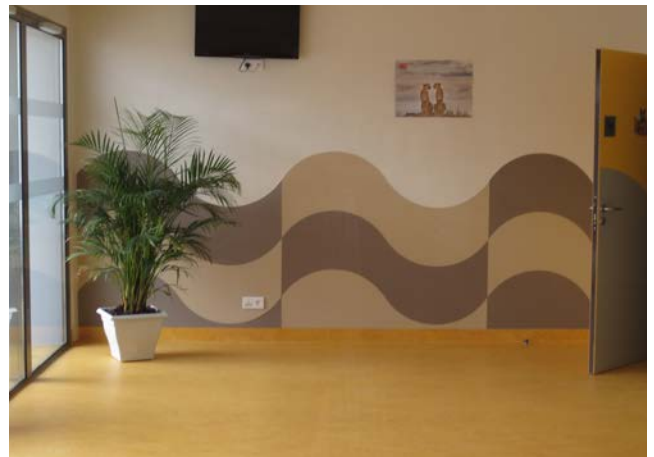
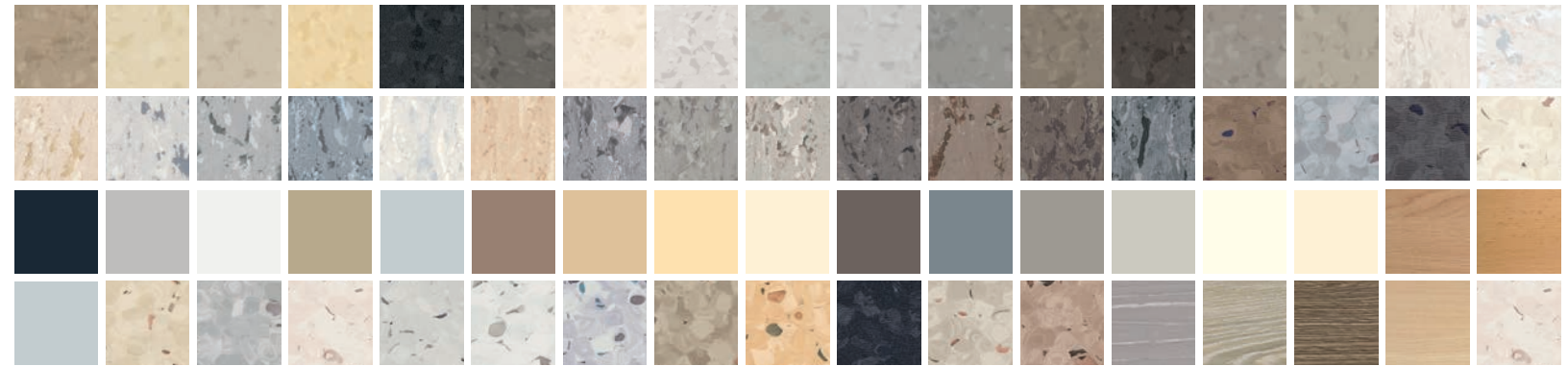

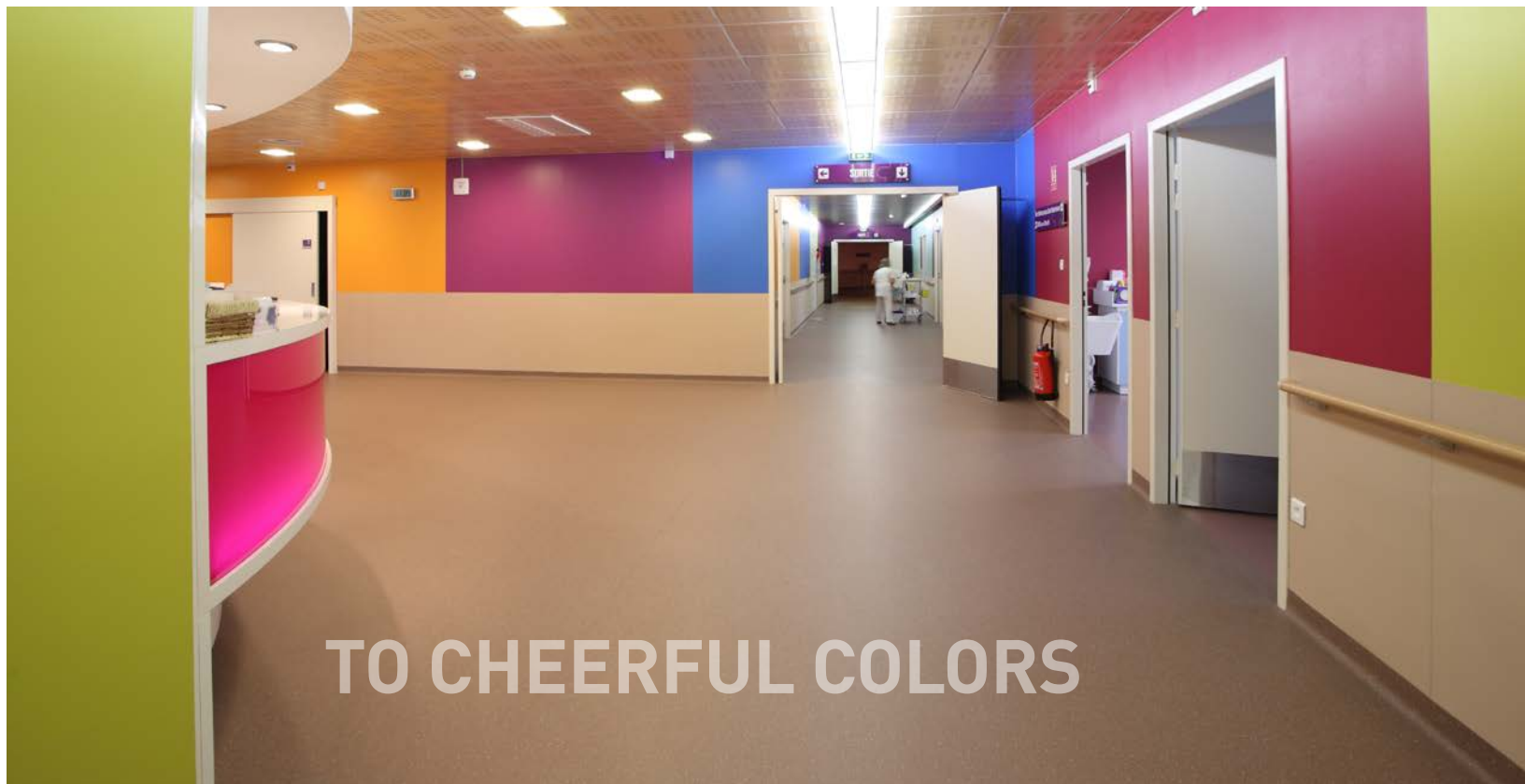
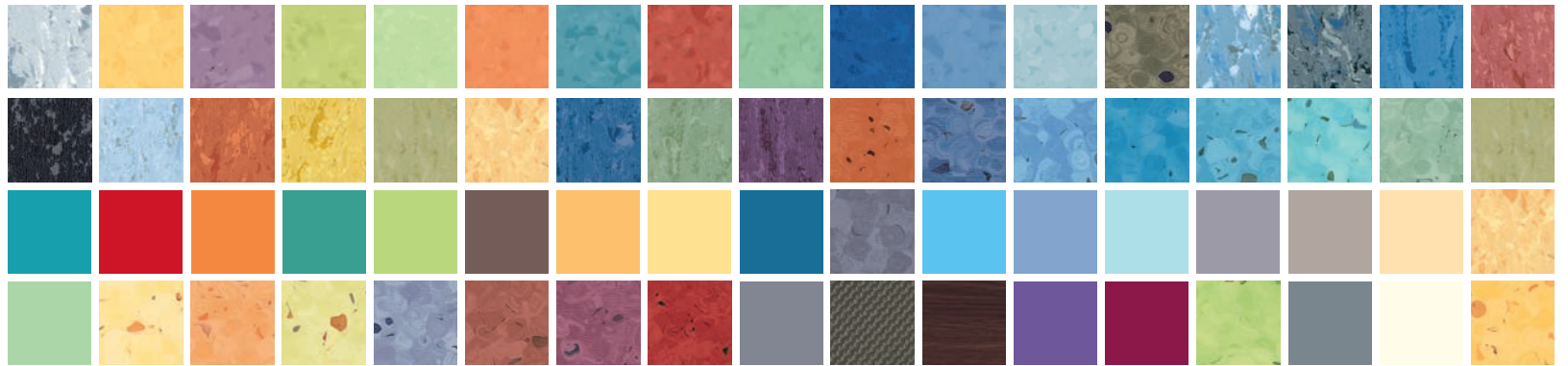

TO CHEERFUL COLORS

Overview

Mipolam Wall extends wall life by bringing to vertical surfaces the technical innovation and advanced performance of Gerflor USA's industry-leading resilient flooring.

Impact

All Mipolam Wall products are highly impact-resistant and meet Gardner impact requirements, resisting up to 705 lbs at 1.86 miles/hour (320 kg at 3 kmh).

Cleanability

Non-porous and waterproof, Mipolam Wall provides superior stain resistance and stands up to cleaning and sanitizing products. The result: walls that are easy to clean and maintain their good looks.

Hygiene

Designed to maintain demanding hygienic standards, Mipolam Wall is bacteriostatic and ISO 22196-certified to limit spread of infections at 99%. And for the most demanding environments, Mipolam Wall panels can be heat-welded for a continuous, watertight wall-to-floor solution.

Easy Installation

Panels can be installed either vertically or horizontally. For renovation projects, overnight-installation solutions keep disruption to a minimum.

Sustainability

Mipolam Wall products are made with non-polluting and eco-friendly materials and meet or exceed the requirements of all current regulations. Panels contain no heavy metals or phthalates and are 100% recyclable. They are low VOC, meet ISO 16000 at below 15 $\mu\text{g}/\text{m}^3$, and are REACH compliant.

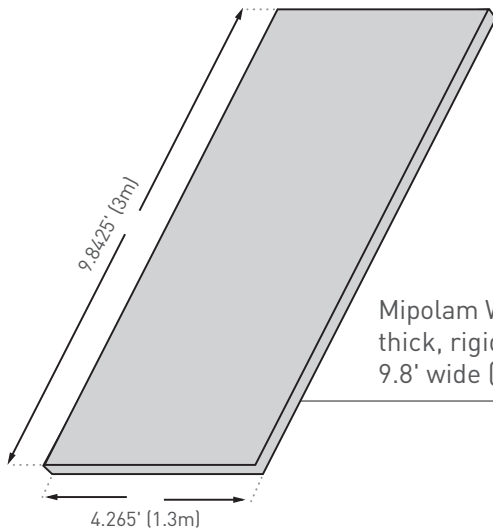

Mipolam Wall is provided in 1/12" (2mm) thick, rigid panels that are 4.2' wide by 9.8' wide (1.3m by 3m).

Keeps walls protected and looking fresh over time.



Add branding or directional elements.



Wide range of colors available.



Perfect for kid-friendly or multipurpose spaces.



Protection, style and easy cleaning for sports and fitness.



Bacteriostatic and easy to maintain, even in busy foodservice areas.



DECOSHOCK

For high-traffic, hygienic environments

Gerflor USA's Mipolam Wall Decoshock collection provides high-impact resistance and is developed specifically for hygienic environments. Offering resilient, homogeneous wall protection, Decoshock is available in a wide range of design options.

Description: 1/12" (2mm) thick, rigid bacteriostatic wall panels with textured embossing.

- Ideal for high-traffic areas with wheeled equipment found in healthcare.
- Unique textured surface conceals impacts and scratches, and is easy to clean.
- Non-porous 100% bacteriostatic material suitable for high-infection-risk areas like healthcare.
- Welded joints for perfect watertightness between panels or with Gerflor flooring.
- Easy to maintain: chemical resistant; resists standard cleaning, disinfecting, and antiseptic products.
- Versatile: 31 easy-to-coordinate colors. Developed for hospitals but trusted in all segments.

DECOSHOCK

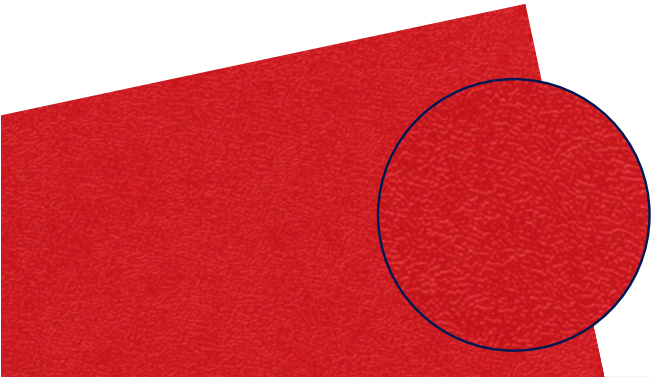

0018 Azure



0019 Ultramarine



0020 Denim



0021 Straw



0022 Apricot



0023 Meadow



0024 Bamboo



0025 Emerald



0027 Melon



0028 Poppy



0029 Garnet



0030 Iris



0001 Chalk

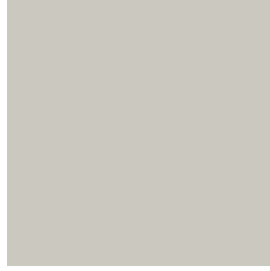

0002 Gravel

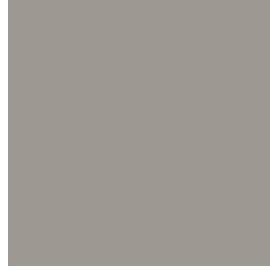

0003 Clay



0004 Granite

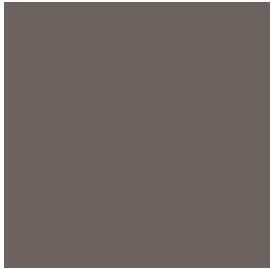

0005 Schist



0006 Ivory



0007 Wicker



0008 Sand



0009 Sienna

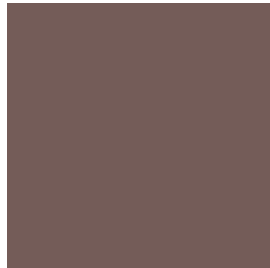

0010 Bark



0011 Pebble



0013 Greige



0014 Cinnamon



0015 Lavender Grey

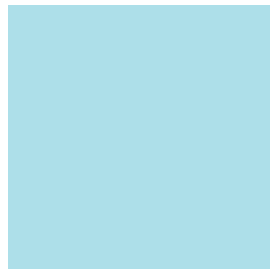

0016 Glacier



0017 Bluebell

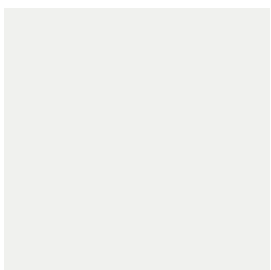

0031 Alum

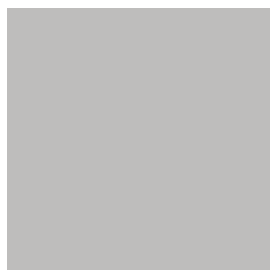

0032 Flint



0033 Slate



0034 Magnolia

DECOSHOCK

DECOSHOCK

Protection from chairs in waiting areas.



Textured surface conceals impact and scratches.



Protects walls from rolling beds and equipment.



Helps prevent impact from balls and other sports equipment.



DECOSHOCK

100% bacteriostatic surface.



Ideal for kid-friendly spaces.



DECOWOOD, DECOTREND AND DECOSMIC

DECOWOOD AND DECOTREND

For welcoming, modern environments

Add the warmth and style of wood or a modern metallic design with Gerflor USA's Mipolam Wall Decowood, Decotrend and Decosmic collections. Ideal for any moderate traffic area for healthcare, education, retail, hospitality, sports and more.

Description: 1/12" (2mm) thick, rigid bacteriostatic wall panels with wood designs and brushed aluminum effect.

Traffic Resistant: Impact resistant.

Hygienic: 100% bacteriostatic, non-porous, waterproof.

Low Maintenance: Chemical resistant, durable, easy to install.

Sustainable: REACH-compliant, GREENGUARD certified, low VOC, 100% recyclable, phthalates-free, non-polluting / non-toxic materials, no heavy metals.

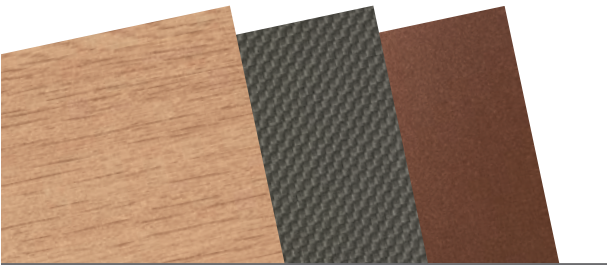

0060 Maple



0061 Beech



0062 Light Oak



0065 Striped Pine

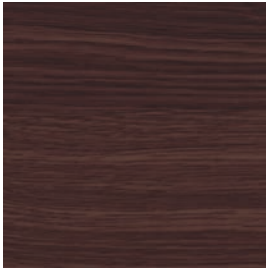

0067 Wenge

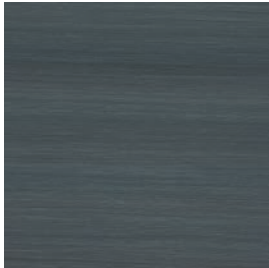

0068 Smoky Cedar



0069 Brown Cedar



0051 Composite



0052 Light Concrete



0053 Medium Concrete



0050 Brushed Alu

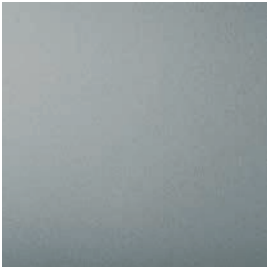

0080 Silver

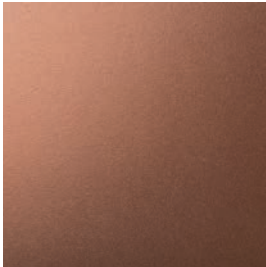

0081 Copper

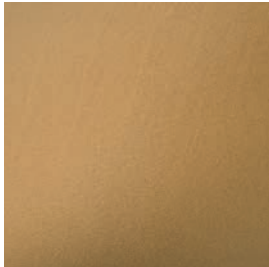

0082 Gold

Vertical grain, floor to ceiling.



Horizontal grain on wainscoting.



Decorative metallic wall protection.



DECOCLEAN

Meets cleanroom requirements

Gerflor USA's Mipolam Wall Decoclean collection offers resilient homogeneous wall protection for healthcare and any area focused on decontamination and preventing infections (Level 4 on the Pasteur scale), in a wide range of design options with a smooth surface finish. Ideal for cleanrooms, controlled environments, labs, intensive care units, sterile environments and more.

Description: 1/12" (2mm) thick, rigid, non-porous, antibacterial homogeneous resilient wall panels with smooth surface.

Hygienic: Meets ISO 5 Cleanroom requirements, 100% antibacterial.

Sterile Environments: Can be welded to floors for a continuous floor-to-wall watertight room.

Low Maintenance: Chemical resistant, durable, easy to install. Delivered with a peel-off protective film to avoid having to do a systematic cleaning after installation.

Sustainable: REACH-compliant, GREENGUARD certified, low VOC, 100% recyclable, phthalates-free, non-polluting / non-toxic materials, no heavy metals.

DECOCLEAN

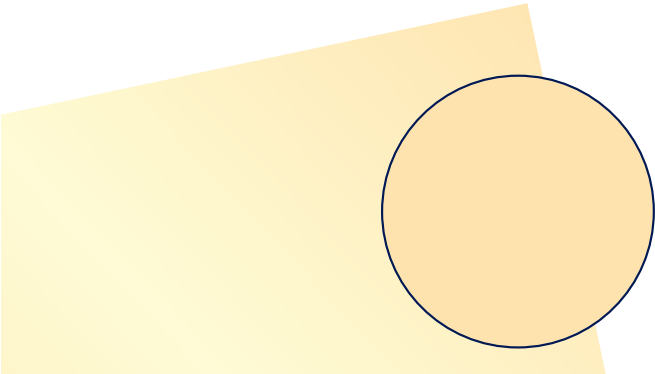

0001 Chalk



0004 Granite

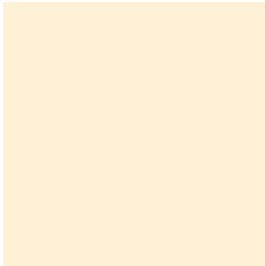

0006 Ivory



0007 Wicker



0011 Pebble

**Continuous, bacteriostatic,
watertight solution.**



**Protection, sanitation
and cleanability.**

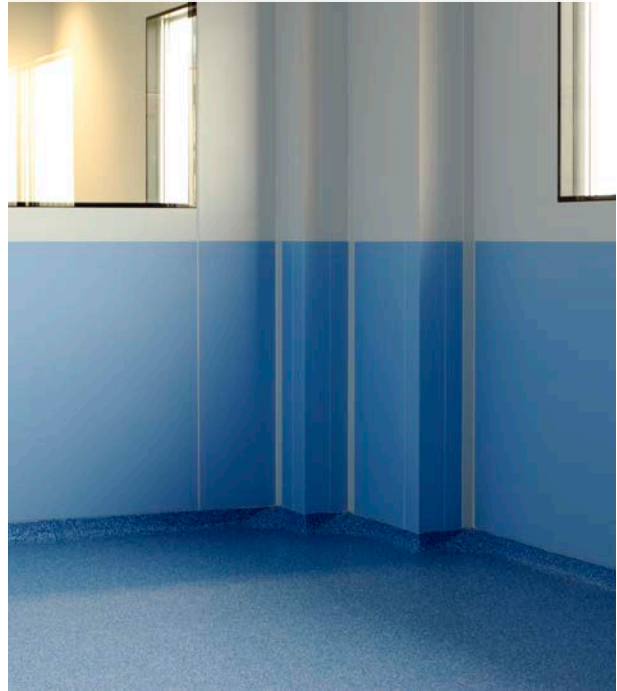

DECOCLEAN

Superior stain and chemical resistance.



MIPOLAM SPM WALL

Installation solutions

- Panels can be adhered with Gerflor acrylic glue or Gerflor universal mastic glue.
- Joints between panels can be made using silicone joints or coordinated weld rods, color-matched to the range.
- Panels can be cut to size or bent into L/U thermoformings.
- Waterjet cutting possible.*

*We recommend working with local vendors for waterjet options

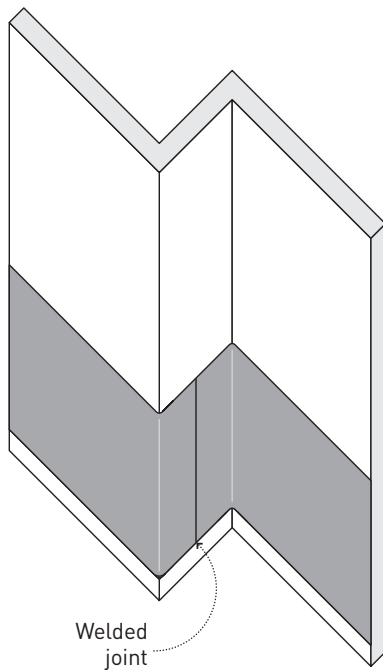

Full installation instructions, specifications and technical drawings can be downloaded at www.gerflorusa.com.

Finishing



Color-coordinated weld rods (328ft/100m)



Color-coordinated silicone joints (10oz/310ml)
(only for non-hygienic environments)

- Fin'alu: finishing or joint profiles in satin silver anodized aluminum (9.8ft/3m)
- Fin'color: color-matching finishing can be used for both finishing and joint profiles in all 31 Decoshock colors.

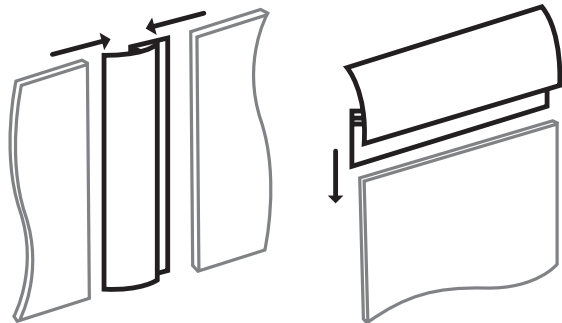

MIPOLAM SPM WALL

DESCRIPTION	STANDARDS	DECOSHOCK	DECOCLEAN	DECOWOOD	DECOTREND
PRODUCT DESCRIPTION					
Description	-	Non-porous antibacterial decorative rigid wall panels providing protection and extending the life of walls. Can be installed vertically or horizontally and can be welded to the floor for continuous floor to wall solution for acute hygienic installations.			
Emboss	-	Lightly embossed texture conceals scratches from impact	Smooth surface for highly hygienic areas	Wood printed designs	Metal effect
Standard Width and Length	-	4.265 feet (1.3 m) x 9.8 ft (3 m)			
Other Width and Length	-	4 feet x 8 feet or 4 feet x 10 feet			
Total Thickness	-	0.08 inch (2 mm)			
Weight	-	0.57 lbs/sqf (2.8 kg/sqm)			
PERFORMANCE					
Impact resistance (Gardner Impact)	ASTM D5420	Meets requirements			
Maximum impact resistance limit	-	705 lbs at 1.86 miles/hour (Resists to 320 kg at 3 km/h impacts)			
Impact resistance	ISO 8256	443 KJ/m ²			
Stain resistance	ASTM D543	Meets requirements			
Chemical & Stain Resistance	ASTM F925	Meets requirements			
Bacteriostatic	ASTM G21	Meets requirements			
Cleanroom	ASTM F51/F68	Meets requirements Class A - non-shedding			
Fire Rating (Surface burning)	ASTM E-84	Class A			
ENVIRONMENT HEALTH & SAFETY					
Indoor Air Quality / Low Emitting Materials	EQc2 LEED v4	GREENGUARD			
Low VOC - TVOC after 28 Days	ISO 160000-6	< 15 µg/m ³			
Bacteriostatic Activity: Combats MRSA, E. coli and S. aureus*	ISO 22196	Inhibits spread of infection at 99%			
Restriction Use of Harmful Chemicals	MRc4 LEED v4	Complies with REACH			
Allergen Free	-	OK			
Plant Certifications	-	ISO 14001, ISO 9001			
Production Waste	MRc3 LEED v4	100% Manufacturing Waste Recycled			
End of Life	-	100% recyclable			
WARRANTY	10-year limited manufacturer warranty when installed in accordance with Gerflor USA's installation instructions available on www.gerflorusa.com .				

*The implementation of an effective cleaning method is the best defense against infection.

Samples & Ordering

Request samples from samples@gerflorusa.com, or contact Gerflor USA's customer service team at 877-437-3567.

All panels are in stock in standard sizes (4.2 feet x 9.8 feet) in France. Allow 10-12 weeks transit time.

For special orders of 4 feet x 8 feet panels, allow an additional two weeks. No minimum required.

For 4 feet x 10 feet panels, add four weeks. Minimum quantity per color: 300 panels.



GERFLOR USA
 877.437.3567
 info@gerflorusa.com

gerflorusa.com

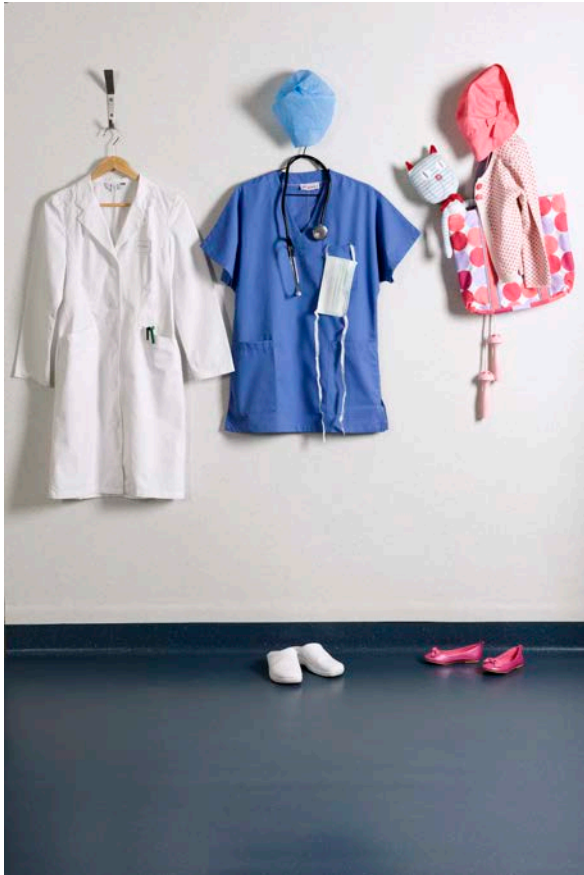

Mipolam SPM Wall

- 1/12" rigid, non-porous, waterproof, bacteriostatic homogeneous wall protection.
- Impact resistance from wheeled traffic.
 - Meets Gardner impact requirements.
 - Resist up to 705 /lbs at 1.86 mp/h (320 kg at 3 km/h).
- Limits the spread of infections at 99% (ISO 22196).
- Superior stain and chemical resistance.
- Installs quickly, looks great, and is easy to clean and maintain.

SAMPLES:
samples@gerflorusa.com

ORDERS:
orders@gerflorusa.com

Updated September 2018.



Committed to Sustainable Development



Follow us on social media!

